



BEACH RULES STANDING 2013 - 2016

**To be applied in all
World, International, National and League Competitions
from 1st December 2013**

*Approved by the
World ParaVolley Board of Directors*

CONTENTS

GAME CHARACTERISTICS	5
PART 1 PHILOSOPHY OF RULES AND REFEREEING	6
PART 2 SECTION 1: GAME.....	8
CHAPTER 1: FACILITIES AND EQUIPMENT	9
1. PLAYING AREA	9
1.1. DIMENSIONS.....	9
1.2. PLAYING SURFACE	9
1.3. LINES ON THE COURT.....	9
1.4. ZONES AND AREAS.....	10
1.5. WEATHER.....	10
1.6. LIGHTING	10
2. NET AND POSTS	10
2.1. HEIGHT OF THE NET.....	10
2.2. STRUCTURE.....	10
2.3. SIDE BANDS.....	11
2.4. ANTENNAE.....	11
2.5. POSTS.....	11
2.6. ADDITIONAL EQUIPMENT.....	11
3. BALLS.....	11
3.1. STANDARDS	11
3.2. UNIFORMITY OF BALLS	12
3.3. THREE-BALL SYSTEM.....	12
CHAPTER 2: PARTICIPANTS.....	13
4. TEAMS	13
4.1. TEAM COMPOSITION	13
4.2. LOCATION OF THE TEAM	13
4.3. EQUIPMENT.....	13
4.4. CHANGE OF EQUIPMENT.....	13
4.5. FORBIDDEN OBJECTS	14
4.6. PROSTHETIC LIMBS	14
5. TEAM LEADERS.....	14
5.1. CAPTAIN.....	14
CHAPTER 3: PLAYING FORMAT	16
6. TO SCORE A POINT, TO WIN A SET AND THE MATCH	16
6.1. TO SCORE A POINT.....	16
6.2. TO WIN A SET.....	16
6.3. TO WIN THE MATCH	16
6.4. DEFAULT AND INCOMPLETE TEAM.....	16
7. STRUCTURE OF PLAY.....	17
7.1. THE TOSS.....	17
7.2. OFFICIAL WARM-UP SESSION	17
7.3. TEAM STARTING LINE-UP	17
7.4. POSITIONS.....	17
7.5. POSITIONAL FAULT	18
7.6. SERVICE ORDER.....	18
7.7. SERVICE ORDER FAULT.....	18
CHAPTER 4: PLAYING ACTIONS.....	19
8. STATES OF PLAY	19
8.1. BALL IN PLAY.....	19
8.2. BALL OUT OF PLAY.....	19
8.3. BALL "IN"	19

8.4.	BALL "OUT"	19
9.	PLAYING THE BALL	19
9.1.	TEAM HITS	19
9.2.	CHARACTERISTICS OF THE HIT	20
9.3.	FAULTS IN PLAYING THE BALL	20
10.	BALL AT THE NET	21
10.1.	BALL CROSSING THE NET	21
10.2.	BALL TOUCHING THE NET	21
10.3.	BALL IN THE NET	21
11.	PLAYER AT THE NET	21
11.1.	REACHING BEYOND THE NET	21
11.2.	PENETRATION INTO THE OPPONENT'S SPACE, COURT AND/OR FREE ZONE	22
11.3.	CONTACT WITH THE NET	22
11.4.	PLAYER'S FAULTS AT THE NET	22
12.	SERVICE	22
12.1.	FIRST SERVICE IN A SET	22
12.2.	SERVICE ORDER	22
12.3.	AUTHORISATION OF THE SERVICE	23
12.4.	EXECUTION OF THE SERVICE	23
12.5.	SCREENING	23
12.6.	FAULTS MADE DURING THE SERVICE	23
13.	ATTACK HIT	24
13.1.	CHARACTERISTICS OF THE ATTACK HIT	24
13.2.	FAULTS OF THE ATTACK HIT	24
14.	BLOCK	24
14.1.	BLOCKING	24
14.2.	BLOCK CONTACT	24
14.3.	BLOCKING WITHIN THE OPPONENT'S SPACE	25
14.4.	BLOCK AND TEAM HITS	25
14.5.	BLOCKING THE SERVICE	25
14.6.	BLOCKING FAULTS	25
CHAPTER 5: INTERRUPTIONS, DELAYS AND INTERVALS		26
15.	INTERRUPTIONS	26
15.1.	NUMBER OF REGULAR INTERRUPTIONS	26
15.2.	SEQUENCE OF REGULAR GAME INTERRUPTIONS	26
15.3.	REQUEST FOR REGULAR GAME INTERRUPTIONS	26
15.4.	TIME-OUTS AND TECHNICAL TIME-OUTS	26
15.5.	IMPROPER REQUESTS	26
16.	GAME DELAYS	27
16.1.	TYPES OF DELAY	27
16.2.	DELAY SANCTIONS	27
17.	EXCEPTIONAL GAME INTERRUPTIONS	27
17.1.	INJURY/ILLNESS	27
17.2.	EXTERNAL INTERFERENCE	28
17.3.	PROLONGED INTERRUPTIONS	28
17.4.	PROSTHETIC FAILURE	28
18.	INTERVALS AND CHANGE OF COURTS/SWITCHES	29
18.1.	INTERVALS	29
18.2.	COURT SWITCHES	29
CHAPTER 6: PARTICIPANTS' CONDUCT		30
19.	REQUIREMENTS OF CONDUCT	30
19.1.	SPORTSMANLIKE CONDUCT	30
19.2.	FAIR PLAY	30
20.	MISCONDUCT AND ITS SANCTIONS	30
20.1.	MINOR MISCONDUCT	30
20.2.	MISCONDUCT LEADING TO SANCTIONS	30

20.3.	SANCTION SCALE.....	31
20.4.	MISCONDUCT BEFORE AND BETWEEN SETS.....	31
20.5.	SUMMARY OF MISCONDUCT AND CARDS USED	31
PART 2 SECTION 2: THE REFEREES, THEIR RESPONSIBILITIES AND OFFICIAL HAND SIGNALS.....		32
CHAPTER 7: REFEREES		33
21.	REFEREEING CORPS AND PROCEDURES.....	33
21.1.	COMPOSITION	33
21.2.	PROCEDURES	33
22.	1 ST REFEREE	34
22.1.	LOCATION	34
22.2.	AUTHORITY	34
22.3.	RESPONSIBILITIES.....	34
23.	2 ND REFEREE.....	35
23.1.	LOCATION	35
23.2.	AUTHORITY	35
23.3.	RESPONSIBILITIES.....	35
24.	SCORER.....	36
24.1.	LOCATION	36
24.2.	RESPONSIBILITIES.....	36
25.	ASSISTANT SCORER	37
25.1.	LOCATION	37
25.2.	RESPONSIBILITIES.....	37
26.	LINE JUDGES	37
26.1.	LOCATION	37
26.2.	RESPONSIBILITIES.....	37
27.	OFFICIAL SIGNALS.....	38
27.1.	REFEREES' HAND SIGNALS	38
27.2.	LINE JUDGES' FLAG SIGNALS.....	38
PART 2 SECTION 3: DIAGRAMS		39
PART 3 - DEFINITIONS.....		40

GAME CHARACTERISTICS

Standing Beach ParaVolley is a sport played by two teams on a sand court divided by a net.

The team has three hits for returning the ball (including the block touch).

In Standing Beach ParaVolley, the team winning a rally scores a point (Rally Point System).

When the receiving team wins a rally, it gains a point and the right to serve; its players “rotate” one position.

PART 1

PHILOSOPHY OF RULES AND REFEREEING

Introduction

Beach Volleyball is one of the most successful and popular competitive and recreational sports in the world. It is **fast**, it is **exciting** and the action is **explosive**. The Beach form of Volleyball comprises several crucial overlapping elements whose complimentary **interactions** render it unique amongst rally games.

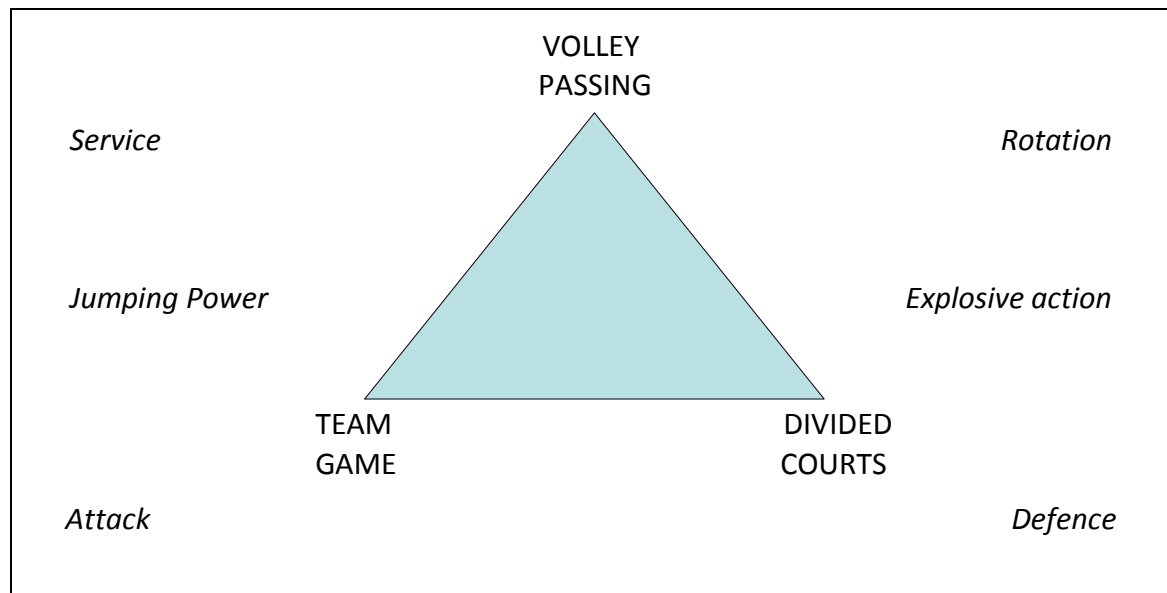

The adoption of Beach ParaVolley as part of the family of *World ParaVolley* sports represents a significant effort to broaden the opportunities for participation of players with a physical impairment and making our game more accessible to a larger audience.

This text is aimed at a broad Volleyball and ParaVolley public – players, coaches, referees, spectators, and commentators – for the following reasons:

- understanding the rules better, allows better play – coaches can create better team structure and tactics, allowing players full rein to display their skills and abilities;
- understanding the relationship between rules allows officials to make better decisions.

This introduction at first focuses on Beach ParaVolley as a competitive sport, before setting out to identify the main qualities required for successful refereeing.

Beach ParaVolley is a Competitive Sport

Competition taps latent strengths. It exhibits the best of ability, spirit, creativity and aesthetics. The rules are structured to allow **all** of these qualities. With a few exceptions, Beach ParaVolley allows all players to operate both at the net (in attack) and in the back of the court (to defend or serve).

The game's early exponents of Beach Volleyball on the sands of California would still recognize Beach ParaVolley because it has retained certain distinctive and essential elements over the years. Some of these it shares with other net/ball/racquet games:

- Service;
- Rotation (taking turns to serve);
- Attack;
- Defence.

Volleyball is, however, unique amongst net games in insisting that the ball is in constant flight – a flying ball – and by allowing each team a degree of internal passing before the ball must be returned to the opponents.

Modifications to the service rule have changed the act of service from simply a means of putting the ball in play to an offensive weapon.

The concept of “rotation” is entrenched to allow for all-round athletes. There are no player positions in order to encourage teams and players to have flexibility and to create interesting developments in tactics.

Competitors use this framework to contest techniques, tactics and power. The framework also allows players a freedom of expression to enthuse spectators and viewers.

The image of Beach ParaVolley is increasingly a good one.

The Referee within this Framework

The essence of a good official lies in the concept of fairness and consistency:

- to **be** fair to every participant,
- to be **viewed** as fair by the spectators.

This demands a huge element of trust – the referee must be trusted to allow the players to entertain:

- by being **accurate** in his/her **judgement**;
- **by understanding why the rule is written**;
- by being an **efficient organizer**;
- by allowing the competition to flow and by **directing** it to a conclusion;
- by being an **educator** – using the rules to penalise the unfair or admonish the impolite;
- by **promoting** the game – that is, by **allowing the spectacular** elements in the game to shine and the players to do what they do best: **entertain** the public.

Finally we can say that a good referee will use the rules to make the competition a fulfilling experience for **all** concerned.

To those who have read thus far, view the rules which follow as the current state of development of a great game, but keep in mind why these preceding few paragraphs may be of equal importance to you in your own position within the sport.

Get involved !

Keep the ball flying !

PART 2

SECTION 1:

GAME

CHAPTER 1: FACILITIES AND EQUIPMENT

		See Rules
1. PLAYING AREA	The playing area includes the playing court and the free zone. It shall be rectangular and symmetrical.	1.1, D1
1.1. DIMENSIONS		D2
1.1.1.	The playing court is a rectangle measuring 16 x 8 m, surrounded by a free zone, which is a minimum of 3 m wide on all sides. The free playing space is the space above the playing area, which is free from all obstructions. The free playing space shall measure a minimum of 7 m in height from the playing surface.	
1.1.2.	For <i>World ParaVolley</i> and Official Competitions as well as Zonal Championships, the free zone is a minimum of 5 m and a maximum of 6 m from the end lines/side lines. The free playing space shall measure a minimum of 12.5 m in height from the playing surface.	
1.2. PLAYING SURFACE		
1.2.1.	The surface must be composed of levelled sand, as flat and uniform as possible, free of rocks, shells and anything else which can represent risks of cuts or injuries to the players.	
1.2.2.	For <i>World ParaVolley</i> and Official Competitions as well as Zonal Championships, the sand must be at least 40 cm deep and composed of fine loosely compacted grains.	
1.2.3.	The playing surface must not present any danger of injury to the players.	
1.2.4.	For <i>World ParaVolley</i> and Official Competitions as well as Zonal Championships, the sand should also be sifted to an acceptable size, not too coarse, and free of stones and dangerous particles. It should not be too fine to cause dust and stick to the skin.	
1.2.5.	For <i>World ParaVolley</i> and Official Competitions as well as Zonal Championships, a tarp to cover the central court is recommended in case of rain.	
1.3. LINES ON THE COURT		D2
1.3.1.	All lines are 5 cm wide. The lines must be of a colour which contrasts sharply with the colour of the sand.	
1.3.2.	Boundary Lines Two side lines and two end lines mark the playing court. There is no centre line. Both side and end lines are placed inside the dimensions of the playing court. Court lines should be ribbons made of a resistant material, and any exposed anchors should be of a soft, flexible material.	

1.4. ZONES AND AREAS

There is only the court, service zone and the free zone surrounding the court.

- 1.4.1. The service zone is an 8 m wide area behind the end line which extends to the edge of the free zone.

1.5. WEATHER

The weather must not present any danger of injury to the players.

1.6. LIGHTING

For *World ParaVolley* and Official Competitions as well as Zonal Championships, played at night, the lighting on the playing area should be 1,000 to 1,500 lux measured at 1 m above the surface of the playing area.

2. NET AND POSTS

2.1. HEIGHT OF THE NET

- 2.1.1. Placed vertically over the middle of the court there is a net whose top is set at the height of 2.43 m for men and 2.24 m for women.

Note: The height of the net may be varied for specific age groups as follows:

Age Groups	Females	Males
16 years and under	2.24 m	2.24 m
14 years and under	2.12 m	2.12 m
12 years and under	2.00 m	2.00 m

- 2.1.2. Its height is measured from the centre of the playing court with a measuring rod. The net height (over the two side lines) must be exactly the same and must not exceed the official height by more than 2 cm.

2.2. STRUCTURE

The net is 8.5 m long and 1 m (+/- 3 cm) wide when it is hung taut, placed vertically over the narrow axis at the middle of the court.

It is made of 10 cm square mesh. At its top and bottom there are two 7-10 cm wide horizontal bands made of two-fold canvas, preferably in dark blue or bright colours, sewn along its full length. Each extremity of the upper band has a hole through which passes a cord fastening the upper band to the posts to keep the top of the net stretched taut.

Within the bands, there is a flexible cable in the upper one and a cord in the bottom one for fastening the net to the posts and keeping its top and bottom taut. It is permissible to have advertising on the horizontal bands of the net.

For *World ParaVolley* and Official Competitions as well as Zonal Championships, an 8.0 m net with smaller meshes and brandings displayed between the ends of the net and the posts may be used, provided that the visibility of the athletes and officials will be preserved. Publicity may be printed on the above items as per *World ParaVolley* regulations.

D3

D3

<p>2.3. SIDE BANDS</p>	<p>D3</p>
<p>Two coloured bands, 5 cm wide (same width as the court lines) and 1 m long, are fastened vertically to the net and placed above each side line. They are considered part of the net.</p> <p>Advertising is permitted on the side bands.</p>	
<p>2.4. ANTENNAE</p>	<p>D2, D3</p>
<p>An antenna is a flexible rod, 1.80 m long and 10 mm in diameter, made of fibreglass or similar material.</p> <p>An antenna is fastened at the outer edge of each side band. The antennae are placed on opposite sides of the net.</p> <p>The top 80 cm of each antenna extends above the net and is marked with 10 cm stripes of contrasting colour, preferably red and white.</p> <p>The antennae are considered as part of the net and laterally delimit the crossing space.</p>	
<p>2.5. POSTS</p>	
<p>2.5.1. The posts supporting the net are placed at a distance of 0.70-1.00 m from each side line to the post padding. They are 2.55 m high and preferably adjustable.</p> <p>For <i>World ParaVolley</i> and Official Competitions as well as Zonal Championships, the posts supporting the net are placed at a distance of 1 m outside the side lines.</p> <p>2.5.2. The posts are rounded and smooth, fixed to the ground without wires. There shall be no dangerous or obstructing devices. Posts must be padded.</p>	<p>D2, D3</p>
<p>2.6. ADDITIONAL EQUIPMENT</p>	
<p>All additional equipment is determined by <i>World ParaVolley</i> regulations.</p>	
<p>3. BALLS</p>	<p>3.2</p>
<p>3.1. STANDARDS</p> <p>The ball shall be spherical, made of a flexible material (leather, synthetic leather, or similar) which does not absorb moisture, i.e. more suitable to outdoor conditions since matches can be played when it is raining. The ball has a bladder inside made of rubber or a similar material. Approval of synthetic leather material is determined by <i>World ParaVolley</i> regulations.</p> <p>Colour: light colours or a combination of colours.</p> <p>Circumference: 66 to 68 cm.</p> <p>Weight: 260 to 280 g.</p> <p>Inside pressure: 0.175 to 0.225 kg/cm² (171 to 221 mbar or hPa).</p>	

3.2. UNIFORMITY OF BALLS

All balls used in a match must have the same standards regarding circumference, weight, pressure, type, colour, etc.

World ParaVolley and Official Competitions as well as Zonal Championships must be played with World ParaVolley approved balls, unless by agreement of World ParaVolley.

3.1

3.3. THREE-BALL SYSTEM

For World ParaVolley and Official Competitions as well as Zonal Championships, three balls shall be used. In this case, six ball retrievers are stationed one at each corner of the free zone and one behind each referee.

D8

CHAPTER 2: PARTICIPANTS

See Rules

4. TEAMS

4.1. TEAM COMPOSITION

- 4.1.1. A team is composed exclusively of three players.
- 4.1.2. Only the three players recorded on the score sheet have the right to participate in the match.
- 4.1.3. One of the players is the team captain who shall be indicated on the score sheet.
- 4.1.4. **For *World ParaVolley* and Official Competitions as well as Zonal Championships, players are not allowed to receive external assistance or coaching during a match.**
- 4.1.5. A maximum of one (1) "A" Classified player is permitted in the team.

4.2. LOCATION OF THE TEAM

The team's areas (including three chairs each) must be 5 m from the sideline, and no closer than 3 m from the scorer's table.

4.3. EQUIPMENT

A player's equipment consists of shorts or a bathing suit. A jersey or "tank-top" is optional except when specified in Tournament Regulations. Players may wear a hat/head covering.

- 4.3.1. **For *World ParaVolley* and Official Competitions as well as Zonal Championships, all players of a given team must wear uniforms of the same colour and style according to tournament regulations. Player's uniforms must be clean.**
- 4.3.2. Players must play barefoot or with a prosthesis except when authorized by the 1st referee.
- 4.3.3. Player's jerseys (or shorts if players are allowed to play without shirt) must be numbered 1, 2 and 3.
 - 4.3.3.1. The number must be placed on the chest (or on the front of the shorts).
 - 4.3.3.2. The numbers must be of a contrasting colour to the jerseys and a minimum of 10 cm in height. The stripe forming the numbers shall be a minimum of 1.5 cm wide.
 - 4.3.3.3. A team may be authorised to play in long pants by the Technical Supervisor for medical or cultural reasons.

4.4. CHANGE OF EQUIPMENT

If both teams arrive at a match dressed in jerseys of the same colour, a toss shall be conducted to determine which team shall change.

4.1.1

The first referee may authorize one or more players:

- 4.4.1. to play with socks and/or shoes,
- 4.4.2. to change wet jerseys between sets provided that the new ones also follow tournament and *World ParaVolley* regulations.
- 4.4.3. If requested by a player, the first referee may authorize him/her to play with undershirts and training pants.

For *World ParaVolley* and Official Competitions as well as Zonal Championships, if one player is authorised to wear an undershirt, tights or training pants, then all players in the team must wear undershirts, tights or training pants of the same colour or style.

4.3.3

4.5. FORBIDDEN OBJECTS

- 4.5.1. It is forbidden to wear objects which may cause injury or give an artificial advantage to the player.
- 4.5.2. Players may wear glasses or lenses at their own risk.

4.6. PROSTHETIC LIMBS

- 4.6.1. Players may wear prosthesis within the considerations of Rule 4.5.1.
- 4.6.2. In the case of the use of prosthetic arm or hand, it cannot be longer than its normal length nor shaped to provide advantage.
- 4.6.3. All prosthetic limbs MUST BE inspected and approved by the Technical Supervisor and/or Classifier before the competition to ensure compliance with the rules, advertising and that they do not provide advantage to the player or present a danger to the players.

5. TEAM LEADERS

The team captain is responsible for maintaining team conduct and discipline.

5.1. CAPTAIN

- 5.1.1. PRIOR TO THE MATCH, the team captain:
 - a) Signs the score sheet.
 - b) Represents his/her team in the toss.
- 5.1.2. During the match, only the captain is authorised to speak to the referees while the ball is out of play in the following three cases:
 - 5.1.2.1. to ask for an explanation on the application or interpretation of the Rules; if the explanation does not satisfy the captain, the captain must immediately inform the 1st referee of his/her wish to Protest;
 - 5.1.2.2. to ask authorisation:
 - a) to change uniforms or equipment,
 - b) to verify the number of the serving player,
 - c) to check the net, the ball, the surface etc.,
 - d) to realign a court line.

8.2

- 5.1.2.3. to request time-outs.

Note: the players must have authorisation from the referees to leave the playing area.

- 5.1.3. AT THE END OF THE MATCH:

- 5.1.3.1. All three players thank the referees and the opponents. The Captain signs the score sheet to ratify the result;

- 5.1.3.2. If the captain previously requested a Protest Protocol via the 1st referee and this has not been successfully resolved at the time of the occurrence, he/she has the right to confirm it as a formal written protest, recorded on the score sheet at the end of the match.

15.2.1, 15.4.1

5.1.2.1

CHAPTER 3: PLAYING FORMAT

See Rules

6. TO SCORE A POINT, TO WIN A SET AND THE MATCH

6.1. TO SCORE A POINT

6.1.1. Point

A team scores a point:

6.1.1.1. by successfully grounding the ball on the opponent's court;

D9 (14)

6.1.1.2. when the opponent team commits a fault;

6.1.1.3. when the opponent team receives a penalty.

6.1.2. Fault

A team commits a fault by making a playing action contrary to the rules (or by violating them in some other way). The referees judge the faults and determine the consequences according to the rules:

6.1.2.1. if two or more faults are committed successively, only the first one is counted;

6.1.2.2. if two or more faults are committed by opponents simultaneously, a **DOUBLE FAULT** is called and the rally is replayed.

D9 (23)

6.1.3. Rally and completed rally

A **rally** is the sequence of playing actions from the moment of the service hit by the server until the ball is out of play. A **completed rally** is the sequence of playing actions which results in the award of a point.

6.1.3.1. If the serving team wins a rally, it scores a point and continues to serve.

6.1.3.2. If the receiving team wins a rally, it scores a point and it must serve next.

6.2. TO WIN A SET

A set (except the deciding 3rd set) is won by the team which first scores 21 points with a minimum lead of two points. In the case of a 20-20 tie, play is continued until a two-point lead is achieved (22-20; 23-21; etc).

D9 (9)

6.3. TO WIN THE MATCH

6.3.1. The match is won by the team that wins two sets.

D9 (9)

6.3.2. In the case of a 1-1 tie, the deciding 3rd set is played to 15 points with a minimum lead of 2 points.

6.4. DEFAULT AND INCOMPLETE TEAM

6.4.1. If a team refuses to play after being summoned to do so, it is declared in default and forfeits the match with the result 0-2 for the match and 0-21, 0-21 for each set.

6.4.2. A team that does not appear on the playing court on time is declared in default.

6.4.1

6.4.3. A team that is declared INCOMPLETE for the set or for the match, loses the set or the match. The opponent team is given the points, or the points and the sets, needed to win the set or the match. The incomplete team keeps its points and sets.

6.2, 6.3, 7.3.1

For World ParaVolley and Official Competitions as well as Zonal Championships, whenever the Pool Play format is implemented, Rule 6.4 above may be subject to modifications as stated in the Specific Competition Regulations issued by the World ParaVolley in due time, establishing the process to be followed for treating the default and incomplete team cases.

7. STRUCTURE OF PLAY

7.1. THE TOSS

Before the official warm up, the 1st referee conducts the toss to decide upon the first service and the sides of the court in the first set.

7.1.1. The toss is taken in the presence of the two team captains, where appropriate.

7.1.2. The winner of the toss chooses:

EITHER

7.1.2.1. the right to serve or to receive the service,

OR

7.1.2.2. the side of the court.

The loser takes the remaining choice.

7.1.3. In the second set the loser of the toss in the first set will have the choice of 7.1.2.1 or 7.1.2.2.

A new toss will be conducted for the deciding set.

7.2. OFFICIAL WARM-UP SESSION

Prior to the match, if the teams have previously had another playing court at their disposal, they will have a 3-minute official warm-up period at the net; if not, they may have 5 minutes.

7.3. TEAM STARTING LINE-UP

7.3.1. All three players of each team must always be in play.

4.1.1

7.4. POSITIONS

At the moment the ball is hit by the server, each team must be within its own court (except the server).

7.4.1. The players are free to position themselves. There are NO determined positions on the court.

7.5. POSITIONAL FAULT

7.5.1. There are NO positional faults.

7.6. SERVICE ORDER

7.6.1. Service order must be maintained throughout the set (as determined by the team captain immediately following the toss).

7.6.2. When the receiving team has gained the right to serve, its players “rotate” one position.

7.7. SERVICE ORDER FAULT

7.7.1. A service order fault is committed when the service is not made according to the service order. The team is sanctioned with a point and service to the opponent.

7.7.2. The scorer(s) must correctly indicate the service order and correct any incorrect server.

D9 (13)

CHAPTER 4: PLAYING ACTIONS

		See Rules
8.	STATES OF PLAY	
8.1.	BALL IN PLAY	
	The ball is in play from the moment of the hit of the service authorized by the 1 st referee.	12, 12.3
8.2.	BALL OUT OF PLAY	
	The ball is out of play at the moment of the fault which is whistled by one of the referees; in the absence of a fault, at the moment of the whistle.	
8.3.	BALL "IN"	
	The ball is "in" when it touches the surface of the playing court including the boundary lines.	D9 (14), D10 (1)
8.4.	BALL "OUT"	
	The ball is "out" when it:	
8.4.1.	falls on the ground completely outside the boundary lines (without touching them);	1.3.2, D9 (15), D10 (2)
8.4.2.	touches an object outside the court, or a person out of play;	D9 (15), D10 (4)
8.4.3.	touches the antennae, ropes, posts or the net itself outside the side bands;	2.3, D3, D4a, D9 (15), D10 (4)
8.4.4.	crosses the vertical plane of the net either partially or totally outside the crossing space during service or during the third hit of the team (exception: Rule 10.1.2);	2.3, 10.1.2, D4a, D9 (15), D10 (4)
8.4.5.	crosses completely the lower space under the net.	D4a, D9 (22)
9.	PLAYING THE BALL	
	Each team must play within its own playing area and playing space (except Rule 10.1.2).	10.1.2
	The ball may, however, be retrieved from beyond the free zone.	
9.1.	TEAM HITS	
	A hit is any contact with the ball by a player in play.	
	Each team is entitled to a maximum of three hits for returning the ball over the net. If more are used, the team commits the fault of "FOUR HITS".	
	These team hits include not only intentional hits by the player, but also unintentional contacts with the ball.	

<p>9.1.1. CONSECUTIVE CONTACTS</p> <p>A player may not hit the ball two times consecutively (exceptions, see Rules: 9.2.3, 14.2 and 14.4.2).</p> <p>9.1.2. SIMULTANEOUS CONTACTS</p> <p>Two/three players may touch the ball at the same moment.</p> <p>9.1.2.1. When two/three teammates touch the ball simultaneously, it is counted as two/three hits (with the exception of blocking).</p> <p>If they reach for the ball but only one of them touches it, one hit is counted.</p> <p>If players collide, no fault is committed.</p> <p>9.1.2.2. When two opponents touch the ball simultaneously over the net and the ball remains in play, the team receiving the ball is entitled to another three hits. If such a ball goes "out", it is the fault of the team on the opposite side.</p> <p>9.1.2.3. If simultaneous hits by two opponents over the net lead to an extended contact with the ball, play continues.</p> <p>9.1.3. ASSISTED HIT</p> <p>Within the playing area, a player is not permitted to take support from a teammate or any structure/object in order to hit the ball.</p> <p>However, a player who is about to commit a fault (touch the net or interfere with an opponent, etc.) may be stopped or held back by a team-mate.</p>	<p>9.2.3, 14.2, 14.4.2, D9 (17)</p> <p>14.2</p> <p>9.1.2.2</p>
9.2. CHARACTERISTICS OF THE HIT	
<p>9.2.1. The ball may touch any part of the body.</p> <p>9.2.2. The ball must not be caught or thrown. It can rebound in any direction.</p> <p>Exceptions:</p> <p>9.2.2.1. in defensive action of a hard driven ball. In this case, the ball contact can be extended momentarily overhand with the fingers.</p> <p>9.2.2.2. if simultaneous contact with the ball over the net by the two opponents leads to an extended contact.</p> <p>9.2.3. The ball may touch various parts of the body, provided that the contacts take place simultaneously.</p> <p>Exceptions:</p> <p>9.2.3.1. at blocking, consecutive contacts may be made by one or more players, provided that they occur during one action;</p> <p>9.2.3.2. at the first hit of the team, unless it is played overhand using fingers (exception Rule 9.2.2.1), the ball may contact various parts of the body consecutively, provided that the contacts occur during one action.</p>	<p>9.3.3</p> <p>14.2</p> <p>9.2.2.1</p>
9.3. FAULTS IN PLAYING THE BALL	
<p>9.3.1. FOUR HITS: a team hits the ball four times before returning it.</p> <p>9.3.2. ASSISTED HIT: a player takes support from a teammate or any structure / object in order to hit the ball within the playing area.</p>	<p>9.1, D9 (18)</p> <p>9.1.3</p>

- | | | |
|--------|--|---------------------------|
| 9.3.3. | CATCH: the ball is caught and/or thrown; it does not rebound from the hit. (Exceptions 9.2.2.1, 9.2.2.2). | 9.2.2.1, 9.2.2.2, D9 (16) |
| 9.3.4. | DOUBLE CONTACT: a player hits the ball twice in succession or the ball contacts various parts of his/her body in succession. | 9.1.1, 9.2.3, D9 (17) |

10. BALL AT THE NET

10.1. BALL CROSSING THE NET

10.1.1.	The ball sent to the opponent's court must go over the net within the crossing space. The crossing space is the part of the vertical plane of the net limited as follows:	D4a
---------	---	-----

10.1.1.1. below, by the top of the net;

10.1.1.2. at the sides, by the antennae, and their imaginary extension;

10.1.1.3. above, by the ceiling or structure (if any).

10.1.2.	The ball that has crossed the net plane to the opponent's free zone totally or partly through the external space, may be played back within the team hits, provided that:	9.1, D4b
---------	---	----------

10.1.2.1.	The ball when played back crosses the vertical plane of the net again totally, or partly through the external space on the same side of the court.	D4b
-----------	--	-----

The opponent team may not prevent such action.

10.1.3.	The ball is "out" when it crosses completely the lower space under the net.	
---------	---	--

10.1.4.	A player, however, may enter the opponents' court in order to play the ball before it crosses completely the lower space or passes outside the crossing space.	10.1.3
---------	--	--------

10.2. BALL TOUCHING THE NET

While crossing the net, the ball may touch it.	10.1.1
--	--------

10.3. BALL IN THE NET

10.3.1.	A ball driven into the net may be recovered within the limits of the three team hits.	9.1
---------	---	-----

10.3.2.	If the ball rips the mesh of the net or tears it down, the rally is cancelled and replayed.	
---------	---	--

11. PLAYER AT THE NET

11.1. REACHING BEYOND THE NET

11.1.1.	In blocking, a player may touch the ball beyond the net, provided that he/she does not interfere with the opponent's play, before or during the latter's attack hit.	14.1, 14.3
---------	--	------------

11.1.2.	After an attack hit, a player is permitted to pass his/her hand beyond the net, provided that the contact has been made within his/her own playing space.	
---------	---	--

11.2. PENETRATION INTO THE OPPONENT'S SPACE, COURT AND/OR FREE ZONE

11.2.1. A player may enter into the opponent's space, court and/or free zone, provided that this does not interfere with the opponent's play.

11.3. CONTACT WITH THE NET

11.3.1. Contact with the net by a player is not a fault, unless it interferes with the play.

11.3.2. Players may touch the post, ropes, or any other object outside the antennae, including the net itself, provided that it does not interfere with the play.

11.3.3. When the ball is driven into the net, causing it to touch an opponent, no fault is committed.

11.4. PLAYER'S FAULTS AT THE NET

11.4.1. A player touches the ball or an opponent in the opponent's space before or during the opponent's attack hit.

11.4.2. A player interferes with the opponent's play while penetrating into the opponent's space under the net.

11.4.3. A player interferes with the opponent's play by (amongst others):

- touching the top band of the net or the top 80 cm of the antenna during his/her action of playing the ball, or
- taking support from the net simultaneously with playing the ball, or
- creating an advantage over the opponent by touching the net, or
- making actions which hinder an opponent's legitimate attempt to play the ball.

D9 (20)

12. SERVICE

The service is the act of putting the ball into play by the correct serving player placed in the service zone.

12.1. FIRST SERVICE IN A SET

12.1.1. The first service of a set is executed by the team determined by the toss.

6.3.2, 7.1

12.2. SERVICE ORDER

12.2.1. The players must follow the service order recorded on the score sheet.

12.2.2. After the first service in a set, the player to serve is determined as follows:

12.2.2.1. when the serving team wins the rally, the player who served before, serves again.

12.2.2.2. when the receiving team wins the rally, it gains the right to serve and the player determined by the service order of his/her team will serve.

12.3. AUTHORISATION OF THE SERVICE	
The 1 st referee authorizes the service, after having checked that the teams are ready to play and that the server is in possession of the ball.	D9 (1)
12.4. EXECUTION OF THE SERVICE	
12.4.1. The ball shall be hit with one hand or any part of the arm after being tossed or released from the hand(s).	D9 (10)
12.4.2. Only one toss or release of the ball is allowed. Moving the ball in the hands is permitted.	
12.4.3. The server may move freely within the service zone. At the moment of the service hit or take-off for a jump service, the server must not touch the court (the end line included) or the ground outside the service zone. His/her foot may not go under the end line. After the hit, he/she may step or land outside the service zone, or inside the court. If the line moves because of the sand pushed by the server, it is not considered a fault.	1.4.2, D9 (22), D10 (4)
12.4.4. The server must hit the ball within 5 seconds after the 1 st referee whistles for service.	D9 (11)
12.4.5. A service executed before the referee's whistle is cancelled and repeated.	D9 (23)
12.4.6. If the ball, after having been tossed or released by the server, lands without being touched or caught by the server, it is considered as a service.	
12.4.7. No further service attempt will be permitted.	
12.5. SCREENING	D9 (12)
12.5.1. A player of the serving team must not prevent the opponent, through individual or collective screening, from seeing the server and the flight path of the ball.	D5
12.5.2. One or two players of the serving team makes a screen by waving arms, jumping or moving sideways or by standing grouped during the execution of the service to hide the server and the flight path of the ball.	D5
12.6. FAULTS MADE DURING THE SERVICE	
12.6.1. Serving faults The following faults lead to a change of service. The server:	
12.6.1.1. violates the service order,	12.2, D9 (13)
12.6.1.2. does not execute the service properly.	12.4
12.6.2. Faults after the service hit After the ball has been correctly hit, the service becomes a fault if the ball:	
12.6.2.1. touches a player of the serving team or fails to cross the vertical plane of the net completely through the crossing space;	D9 (19)
12.6.2.2. goes "out";	8.4, D9 (15)
12.6.2.3. passes over a screen.	D5

13.	ATTACK HIT	
13.1.	CHARACTERISTICS OF THE ATTACK HIT	
13.1.1.	All actions which direct the ball towards the opponent, with the exception of service and block, are considered as attack hits.	
13.1.2.	An attack-hit is completed the moment the ball completely crosses the vertical plane of the net or is touched by an opponent.	
13.1.3.	Any player may carry out an attack-hit at any height, provided that his/her contact with the ball has been made within the player's own playing space (except Rule 13.2.4, 13.2.5 below).	13.2.4, 13.2.5
13.2.	FAULTS OF THE ATTACK HIT	
13.2.1.	A player hits the ball within the playing space of the opposing team.	13.1.2, D9 (20)
13.2.2.	A player hits the ball "out".	8.4, D9 (15)
13.2.3.	A player completes an attack-hit using an open-handed finger action or if using finger tips that are not rigid and together.	D9 (21)
13.2.4.	A player completes an attack hit on the opponent's service, when the ball is entirely higher than the top of the net.	D9 (21)
13.2.5.	A player completes an attack-hit using an overhand pass which has a trajectory not perpendicular to the line of the shoulders. The exception is when the player is attempting to set to his or her teammate.	D9 (21)
14.	BLOCK	
14.1.	BLOCKING	
14.1.1.	Blocking is the action of players close to the net to intercept the ball coming from the opponent by reaching higher than the top of the net, regardless of the height of the ball contact. At the moment of the contact with the ball, a part of the body must be higher than the top of the net.	
14.1.2.	Block Attempt A block attempt is the action of blocking without touching the ball.	
14.1.3.	Completed Block A block is completed whenever the ball is touched by a blocker.	D6
14.1.4.	Collective Block A collective block is executed by two/three players close to each other, and is completed when one of them touches the ball.	
14.2.	BLOCK CONTACT	
	Consecutive (quick and continuous) contacts may occur by one or more blockers provided that the contacts are made during one action. These are counted as only one team hit. These contacts may occur with any part of the body.	9.1.1, 9.2.3

14.3. BLOCKING WITHIN THE OPPONENT'S SPACE	
In blocking, the player may place his/her hands and arms beyond the net, provided that this action does not interfere with the opponent's play. Thus, it is not permitted to touch the ball beyond the net until an opponent has executed an attack hit.	13.1.1
14.4. BLOCK AND TEAM HITS	
14.4.1. A blocking contact is counted as a team hit. The blocking team will have only two more hits after a blocking contact.	
14.4.2. The first hit after the block may be executed by any player, including any player who had touched the ball during the block.	
14.5. BLOCKING THE SERVICE	D9 (12)
To block an opponent's service is forbidden.	
14.6. BLOCKING FAULTS	
14.6.1. The blocker touches the ball in the OPPONENT'S space either before or simultaneously with the opponent's attack hit.	14.3, D9 (20)
14.6.2. Blocking the ball in the opponent's space from outside the antenna.	
14.6.3. A player blocks the opponent's service.	D9 (12)
14.6.4. The ball is sent "out" off the block.	D9 (24)

CHAPTER 5: INTERRUPTIONS, DELAYS AND INTERVALS

See Rules

15. INTERRUPTIONS

An interruption is the time between one completed rally and the 1st referee's whistle for the next service.

The only **regular game** interruptions are TIME-OUTS.

D9 (4)

15.1. NUMBER OF REGULAR INTERRUPTIONS

Each team may request a maximum of one time-out per set.

15.2. SEQUENCE OF REGULAR GAME INTERRUPTIONS

15.2.1. Request for time-out by both teams may follow one another, within the same interruption.

15.2.2. There are no substitutions.

15.3. REQUEST FOR REGULAR GAME INTERRUPTIONS

Regular game interruptions may be requested only by the captain.

15.4. TIME-OUTS AND TECHNICAL TIME-OUTS

15.4.1. Time-out requests must be made by showing the corresponding hand signal, when the ball is out of play and before the whistle for service. All requested time-outs last for 30 seconds

D9 (4)

15.4.2. **For *World ParaVolley* and Official Competitions as well as Zonal Championships, in sets 1 and 2, one additional 30-second "Technical Time-Out" is applied automatically when the sum of the points scored by the teams equals 21 points.**

15.4.3. In the deciding (3rd) set, there are no "Technical Time-Outs"; only one time-out of 30 seconds duration may be requested by each team.

15.4.4. During all regular interruptions and set intervals, players must go to the designated players' area.

15.5. IMPROPER REQUESTS

Among others, it is improper to request a time-out:

15.5.1. during a rally or at the moment of, or after the whistle to serve,

15.5.2. by a non-authorized team member,

15.5.3. after having exhausted the authorized time-outs.

15.1

15.5.4. Any improper request that does not affect or delay the game shall be rejected without any sanction unless repeated in the same match.

15.5, 16.1

15.5.5. Any further improper request in the same match by the same team constitutes a delay.

D9 (25)

16. GAME DELAYS

16.1. TYPES OF DELAY

An improper action of a team that defers resumption of the game is a delay and includes, among others:

- 16.1.1. prolonging time-outs, after having been instructed to resume the game;
- 16.1.2. repeating an improper request;
- 16.1.3. delaying the game (12 seconds shall be the maximum time from the end of a rally to the whistle for service under normal playing conditions);
- 16.1.4. delaying the game by a team member.

15.5

16.2. DELAY SANCTIONS

16.2.1. "Delay warning" and "delay penalty" are team sanctions.

16.2.1.1. Delay sanctions remain in force for the entire match.

16.2.1.2. All delay sanctions are recorded on the score sheet.

16.2.2. The first delay in the match by a team member is sanctioned with a "DELAY WARNING".

D9 (25), D7b

16.2.3. The second and subsequent delays of any type by any member of the same team in the same match constitute a fault and are sanctioned with a "DELAY PENALTY": a point and service to the opponent.

D9 (25), D7b

16.2.4. Delay sanctions imposed before or between sets are applied in the following set.

17. EXCEPTIONAL GAME INTERRUPTIONS

17.1. INJURY/ILLNESS

17.1.1. Should a serious accident occur while the ball is in play, the referee must stop the game immediately and permit medical assistance to enter the court.

The rally is then replayed.

17.1.2. An injured/ill player is given a maximum of 5 minutes recovery time, one time in a match. The referee must authorize the properly accredited medical staff to enter the playing court to attend the player. Only the 1st referee may authorize a player to leave the playing area without penalty. When the treatment has been completed or if no treatment can be provided, play must resume. The 2nd referee will whistle and request the player to continue. At this time, only the player can judge whether he/she is fit to play.

If the player does not recover or return to the playing area at the conclusion of the recovery time, his/her team is declared incomplete.

6.4.3, 7.3.1

In extreme cases, the doctor of the competition can oppose the return of an injured player.

Note: the recovery time will begin when the properly accredited medical staff member(s) of the competition arrives at the playing court to attend to the player. In the event that no accredited medical staff is available or in cases where the player chooses to be treated by his/her own medical personnel, the time will begin from the moment the recovery time was authorized by the referee.

17.2. EXTERNAL INTERFERENCE

If there is any external interference during the game, the play has to be stopped and the rally is replayed.

17.3. PROLONGED INTERRUPTIONS

- 17.3.1. If unforeseen circumstances interrupt the match, the 1st referee, the organizer and the Control Committee, if there is one, shall decide the measures to be taken to re-establish normal conditions.
- 17.3.2. Should one or several interruptions occur not exceeding 4 hours in total, the match is resumed with the score acquired, regardless of whether it continues on the same court or another court.
- 17.3.3. Should one or several interruptions occur, exceeding 4 hours in total, the whole match shall be replayed.

17.4. PROSTHETIC FAILURE

- 17.4.1. Should a minor failure of a prosthetic device occur during a match, the player will be given a small amount of time to re-establish the integrity of the prosthesis.
- 17.4.2. Should this occur more than once during the match, the player will have a maximum of 1 minute to complete repairs without delaying the match. This 1 minute repair delay will only be allowed once in a match for that team.
- 17.4.3. Should a major failure of a prosthetic device occur during a match, the player will be given a maximum of 5-minutes repair time, once in a match. The 1st referee will signal the start of a 5-minute repair time-out. The 1st referee must authorise any properly accredited repair or medical staff to enter the playing court to attend the player. Only the 1st referee may authorise a player to leave the playing area without penalty. At the conclusion of the 5-minutes repair time-out, the 1st referee will whistle and request the player to continue. At this time, only the player can judge whether he/she is fit to play.

If the player does not return to the playing area at the conclusion of the repair time, his/her team is declared incomplete.

In extreme cases, the doctor of the competition and/or the Technical Supervisor can oppose the return of a player.

Note: the repair time will begin when repair time was authorized by the 1st referee.
- 17.4.4. The team will be limited to two (2) repair time requests per match.

18. INTERVALS AND CHANGE OF COURTS/SWITCHES

18.1. INTERVALS

18.1.1. An interval is the time between sets. All intervals last one minute.

During this period of time, the change of courts (if requested) and service order of the teams on the score sheet are made.

D9 (3)

During the interval before a deciding set, the referees carry out a toss in accordance with Rule 7.1.

18.2. COURT SWITCHES

18.2.1. The teams switch after every 7 points (Set 1 and 2) and 5 points (Set 3) played.

D9 (3)

18.2.2. During court switches the teams must change immediately without delay.

If the court switch is not made at the proper time, it will take place as soon as the error is noticed.

The score at the time that the court switch is made remains the same.

CHAPTER 6: PARTICIPANTS' CONDUCT

See Rules

19. REQUIREMENTS OF CONDUCT

19.1. SPORTSMANLIKE CONDUCT

19.1.1. Participants must know the "Official Standing Beach Volleyball Rules" and abide by them.

19.1.2. Participants must accept referees' decisions with sportsmanlike conduct, without disputing them.

In case of doubt, clarification may be requested only through the captain.

19.1.3. Participants must refrain from actions or attitudes aimed at influencing the decisions of the referees or covering up faults committed by their team.

5.1.2.1

19.2. FAIR PLAY

19.2.1. Participants must behave respectfully and courteously in the spirit of FAIR PLAY, not only towards the referees, but also towards other officials, the opponent, team members and spectators.

19.2.2. Communication between team members during the match is permitted.

20. MISCONDUCT AND ITS SANCTIONS

20.1. MINOR MISCONDUCT

Minor misconduct offences are not subject to sanctions. It is the 1st referee's duty to prevent the teams from approaching the sanctioning level.

This is done in two stages:

Stage 1: by issuing a verbal warning through the captain;

Stage 2: by use of a YELLOW CARD to a team member. This formal warning is not in itself a sanction but a symbol that the team member (and by extension the team) has reached the sanctioning level for the match. It is recorded in the score sheet but has no immediate consequences.

5.1.2, 22.3.2.1

D9 (5)

20.2. MISCONDUCT LEADING TO SANCTIONS

Incorrect conduct by a team member towards officials, opponents, teammates or spectators is classified in three categories according to the seriousness of the offence.

20.2.1. Rude conduct: acting contrary to good manners or moral principles,

20.2.2. Offensive conduct: defamatory or insulting words or gestures including any action expressing contempt,

20.2.3. Aggression: actual physical attack or aggressive or threatening behaviour.

4.1.1

20.3. SANCTION SCALE	
<p>According to the judgment of the 1st referee and depending on the seriousness of the offence, the sanctions to be applied and recorded on the score sheet are: Penalty, Expulsion or Disqualification.</p>	D7a
<p>20.3.1. Penalty</p> <p>For rude conduct or a single repetition of rude conduct in the same set by the same player. On each of the first two occasions, the team is sanctioned with a point and service to the opponents. A third rude conduct by a player in the same set is sanctioned by expulsion. Rude conduct sanctions may, however, be given to the same player in subsequent sets.</p>	D9 (6)
<p>20.3.2. Expulsion</p> <p>The first offensive conduct is sanctioned by expulsion. The player who is sanctioned with expulsion must leave the playing area and his/her team is declared incomplete for the set.</p>	6.4.3, 7.3.1, D9 (7)
<p>20.3.3. Disqualification</p> <p>The first physical attack or implied or threatened aggression is sanctioned by disqualification. The player must leave the playing area and his/her team is declared incomplete for the match.</p> <p>MISCONDUCT is sanctioned as shown in the sanction scale.</p>	6.4.3, 7.3.1, D9 (8) D7a
20.4. MISCONDUCT BEFORE AND BETWEEN SETS	
<p>Any misconduct occurring before or between sets is sanctioned according to the sanction scale and the sanction is applied in the following set.</p>	D7a
20.5. SUMMARY OF MISCONDUCT AND CARDS USED	D9 (5,6,7,8)
<p>Warning: no sanction - Stage 1: verbal warning Stage 2: symbol Yellow Card</p>	20.1
<p>Penalty: sanction - symbol Red card</p>	20.3.1, D7a
<p>Expulsion: sanction - symbol Red + Yellow cards jointly</p>	20.3.2, D7a
<p>Disqualification: sanction - symbol Red + Yellow cards separately</p>	20.3.3, D7a

PART 2

SECTION 2:

THE REFEREES, THEIR RESPONSIBILITIES AND OFFICIAL HAND SIGNALS

CHAPTER 7: REFEREES

See Rules

21. REFEREEING CORPS AND PROCEDURES

21.1. COMPOSITION

The refereeing corps for a match is composed of the following officials:

- the 1st referee,
- the 2nd referee,
- the scorer,
- four (two) line judges

Their location is shown in the Diagram 8.

For *World ParaVolley* and Official Competitions as well as Zonal Championships, an assistant scorer is compulsory.

21.2. PROCEDURES

21.2.1. Only the 1st and 2nd referees may blow a whistle during the match:

21.2.1.1. the 1st referee gives the signal for the service that begins the rally. D9 (1)

21.2.1.2. the 1st or 2nd referee signals the end of the rally, provided that they are sure that a fault has been committed and they have identified its nature.

21.2.2. They may blow the whistle when the ball is out of play to indicate that they authorize or reject a team request.

21.2.3. Immediately after the referee blows the whistle to signal **the completion** of the rally, they have to indicate with the official hand signals: 22.2.1.2, 27.1

21.2.3.1. If the fault is whistled by the 1st referee, he/she will indicate in order:

- a) the team to serve; D9 (2)
- b) the nature of the fault;
- c) the player(s) at fault (if necessary).

The 2nd referee will follow the 1st referee's hand signals by repeating them.

21.2.3.2. the fault is whistled by the 2nd referee, he/she will indicate:

- a) the nature of the fault;
- b) the player(s) at fault (if necessary);
- c) the team to serve following the hand signal of the first referee. D9 (2)

In this case, the 1st referee does not show **either the nature of the fault or the player at fault, but only the team to serve.**

21.2.3.3. In the case of a double fault both referees indicate in order:

- a) the nature of the fault;
- b) the players at fault (if necessary);
- c) the team to serve as directed by the first referee.

D9 (23)

D9 (2)

22. 1ST REFEREE

22.1. LOCATION

The 1st referee carries out his/her functions standing on a referee's stand located at one end of the net on the opposite side to the scorer. His/her view must be approximately 50 cm above the net.

D1, D8

22.2. AUTHORITY

22.2.1. The 1st referee directs the match from the start until the end. He/she has authority over all members of the refereeing corps and the members of the teams.

During the match his/her decisions are final. He/she is authorized to overrule the decisions of other members of the refereeing corps, if it is noticed that they are mistaken.

He/she may even replace a member of the refereeing corps who is not performing his/her functions properly.

22.2.2. He/she also controls the work of the ball retrievers.

22.2.3. He/she has the power to decide any matters involving the game, including those not provided for in the Rules.

22.2.4. He/she shall not permit any discussion about his/her decisions.

However, at the request of the captain, the 1st referee will give an explanation on the application or interpretation of the rules upon which he/she has based his/her decision.

If the captain disagrees with the explanation and formally protests, the 1st referee must authorize the commencement of a Protest Protocol.

22.2.5. The 1st referee is responsible for determining before and during the match whether the playing area and the conditions meet playing requirements.

22.3. RESPONSIBILITIES

22.3.1. Prior to the match, the 1st referee:

22.3.1.1. inspects the conditions of the playing area, the balls and other equipment;

22.3.1.2. performs the toss with the team captains;

22.3.1.3. controls the teams' warming-up.

22.3.2. During the match, he/she is authorized:

22.3.2.1. to issue warnings to the teams;

22.3.2.2. to sanction misconduct and delays;

- 22.3.2.3. to decide upon:
- a) the faults of the server and the screen of the serving team; D5
 - b) the faults in playing the ball;
 - c) the faults above the net, and the faulty contact of the player with the net, primarily on the attacker's side;
 - d) the ball crossing completely the lower space under the net; D9 (22)
- 22.3.3. At the end of the match, he/she checks the score sheet and signs it.

23. 2ND REFEREE

23.1. LOCATION

The 2nd referee performs his/her functions standing outside the playing court near the post, on the opposite side of and facing the 1st referee. D1, D8

23.2. AUTHORITY

- 23.2.1. The 2nd referee is the assistant of the 1st referee, but has also his/her own range of jurisdiction. 23.3
- Should the 1st referee be unable to continue his/her work, the 2nd referee may replace him/her.
- 23.2.2. He/she may, without whistling, also signal faults outside his/her range of jurisdiction, but must not insist upon them to the 1st referee.
- 23.2.3. He/she controls the work of the scorer(s).
- 23.2.4. He/she reports any misconduct to the 1st referee.
- 23.2.5. He/she authorizes the time-outs and court switches, controls the duration of such and rejects improper requests. D9 (3,4)
- 23.2.6. He/she checks the number of time-outs used by each team and reports to the 1st referee and the players concerned after completion of their time-out.
- 23.2.7. In the case of an injury of a player, the 2nd referee authorizes and assists in managing the recovery time. 17.1.2
- 23.2.8. He/she checks during the match that the balls still meet the requirements of the regulations.
- 23.2.9. He/she conducts the toss between sets 2 and 3, if applicable. He/she then must pass all relevant information to the scorer.

23.3. RESPONSIBILITIES

- 23.3.1. At the start of each set, and whenever necessary, the 2nd referee controls the work of the scorer and checks that the correct server has the ball.
- 23.3.2. During the match, the 2nd referee decides, whistles and signals:
- 23.3.2.1. interference due to penetration into the opponent's court and space under the net; 11.2, D9 (22)
 - 23.3.2.2. the faulty contact of the player with the net primarily on the blocker's side and with the antenna on his/her side of the court; 11.3.1

- 23.3.2.3. the contact of the ball with an outside object; 8.4.2, 8.4.3, D9 (15), D10 (4)
- 23.3.2.4. the ball that crosses the net totally or partly outside the crossing space to the opponent court or touches the antenna on his/her side of the court, including during service; 8.4.3, 8.4.4, D3, D4a, D9 (15)
- 23.3.2.5. the contact of the ball with the sand when the 1st referee is not in position to see the contact;
- 23.3.2.6. the ball recovered completely on the opponent's side under the net. D9 (22)
- 23.3.3. At the end of the match, he/she checks and signs the score sheet.

24. SCORER

24.1. LOCATION

The scorer performs his/her functions seated at the scorer's table on the opposite side of the court from and facing the 1st referee.

D1, D8

24.2. RESPONSIBILITIES

The scorer fills in the score sheet according to the Rules, cooperating with the 2nd referee.

He/she uses a buzzer or other sound device to notify irregularities or give signals to the referees on the basis of his/her responsibilities.

- 24.2.1. Prior to the match and set, the scorer:
 - 24.2.1.1. registers the data of the match and teams, according to procedures in force and obtains the signatures of the captains;
 - 24.2.1.2. records the service order of each team.
- 24.2.2. During the match, the scorer:
 - 24.2.2.1. records the points scored;
 - 24.2.2.2. controls the serving order of each team and indicates any error before the service hit;
 - 24.2.2.3. records the time-outs, checking the number of such, and informs the 2nd referee;
 - 24.2.2.4. notifies the referees of a request for time-out that is improper; 15.5
 - 24.2.2.5. announces to the referees the court switches and the end of the sets;
 - 24.2.2.6. records any sanctions and improper requests;
 - 24.2.2.7. records all other events as instructed by the 2nd referee, i.e. recovery time, prolonged interruptions, external interference, etc.;
 - 24.2.2.8. controls the interval between sets.
- 24.2.3. At the end of the match, the scorer:
 - 24.2.3.1. records the final result;
 - 24.2.3.2. in the case of a protest, with the previous authorization of the 1st referee, writes or permits the captain concerned to write on the score sheet a statement on the incident being protested; 5.1.2.1, 5.1.3.2
 - 24.2.3.3. signs the score sheet, before he/she obtains the signatures of the team captains and then the referees.

25.	ASSISTANT SCORER	
25.1.	LOCATION	D1, D8
	The assistant scorer performs his/her functions seated beside the scorer at the scorer's table.	
25.2.	RESPONSIBILITIES	
	He/she assists with the administrative duties of the scorer's work.	
	Should the scorer become unable to continue his/her work, the assistant scorer substitutes for the scorer.	
25.2.1.	Prior to the match and set, the assistant scorer:	
25.2.1.1.	checks that all information displayed at the scoreboard(s) is correct,	
25.2.2.	During the match, the assistant scorer;	
25.2.2.1.	indicates the serving order of each team by displaying a sign numbered 1 or 2 or 3 corresponding to the player to serve and,	
25.2.2.2.	indicates by use of the buzzer any error to the referees immediately;	
25.2.2.3.	operates the manual scoreboard on the scorer's table;	
25.2.2.4.	checks that the scoreboards agree;	
25.2.2.5.	starts and ends the timing of the Technical Time-outs;	
25.2.2.6.	if necessary, updates the reserve score sheet and gives it to the scorer.	
25.2.3.	At the end of the match, the assistant scorer:	
25.2.3.1.	signs the score sheet.	
26.	LINE JUDGES	
26.1.	LOCATION	D1, D8
	If only two line judges are used, they stand at the corners of the court closest to the right hand of each referee, diagonally at 1 to 2 m from the corner.	
	Each one of them controls both the end line and side line on his/her side.	
	For <i>World ParaVolley</i> and Official Competitions as well as Zonal Championships, when it is compulsory to have four line judges, they stand in the free zone at 1 to 3 m from each corner of the court, on the imaginary extension of the line that they control.	
26.2.	RESPONSIBILITIES	
26.2.1.	The line judges perform their functions by using flags (40 x 40 cm), to signal:	D10
26.2.1.1.	the ball "in" and "out" whenever the ball lands near their line(s). (Note: it is primarily the line judge closest to the path of the ball who is responsible for the signal);	8.3, 8.4, D10 (1,2)
26.2.1.2.	the touches of "out" balls by the team receiving the ball;	8.4, D10 (3)

- | | |
|--|------------------------------------|
| 26.2.1.3. the ball touching the antenna, the served ball and the third hit of the team crossing the net outside the crossing space, etc.; | 8.4.3, 8.4.4, 10.1.1, D4a, D10 (4) |
| 26.2.1.4. any player (except the server) stepping outside of his/her court at the moment of the service hit; | 7.4, 12.4.3, D10 (4) |
| 26.2.1.5. the foot faults of the server; | 12.4.3, D10 (4) |
| 26.2.1.6. any contact with the top 80 cm of the antenna on their side of the court by any player during his/her action of playing the ball or interfering with the play; | 11.3.1, 11.4.3, D3, D10 (4) |
| 26.2.1.7. the ball crossing the net outside the crossing space into the opponent's court or touching the antenna on his/her side of the court. | 10.1.1, D4a, D10 (4) |
| 26.2.1.8. the block touches during the rally. | |
| 26.2.2. At the first referee's request, a line judge must repeat his/her signal. | |

27. OFFICIAL SIGNALS

27.1. REFEREES' HAND SIGNALS

The referees will indicate with the official hand signal the reason for their whistle (the nature of the fault whistled or the purpose of the interruption authorized). The signal has to be maintained for a moment and, if it is indicated with one hand, the hand corresponds to the side of the team which has made the fault or the request.

D9

27.2. LINE JUDGES' FLAG SIGNALS

The line judges must indicate with the official flag signal the nature of the fault called, and maintain the signal for a moment.

D10

PART 2

SECTION 3: DIAGRAMS

PART 3

DEFINITIONS

Competition Control Area	The Competition Control Area is a corridor around the playing court and free zone, which includes all spaces up to the outer barriers or delimitation fence (see Diagram 1a).
Zones	These are sections within the playing area (i.e. playing court and free zone) as defined for a specific purpose (or with special restrictions) within the rule text. These include Service Zone & Free Zone
Lower Space	This is the space defined at its upper part by the bottom of the net and the cord joining it to the posts, at the sides by the posts, and at the bottom by the playing surface.
Crossing Space	<p>The crossing space is defined by:</p> <ul style="list-style-type: none">– the horizontal band at the top of the net;– the antennae and their extension;– the ceiling. <p>The ball must cross to the opponent's COURT through the crossing space.</p>
External Space	The external space is in the vertical plane of the net outside of the crossing and lower spaces.
Unless by agreement of <i>World ParaVolley</i>	This statement recognises that while there are regulations on the standards and specification of equipment and facilities, there are occasions when special arrangements can be made by <i>World ParaVolley</i> in order to promote the game of Beach ParaVolley or to test new conditions.
<i>World ParaVolley</i> Standards	The technical specifications or limits as defined by <i>World ParaVolley</i> to the manufacturers of equipment.
Fault	<p>a) A playing action contrary to the rules.</p> <p>b) A rule violation other than a playing action.</p>
Technical Time-Out	This special mandatory time-out is, in addition to time-outs, to allow the promotion of Beach ParaVolley, analysis of the play and to allow additional commercial opportunities. Technical Time-Outs are mandatory for <i>World ParaVolley</i> and Official competitions and Zonal Championships.
Ball Retrievers	These are personnel whose job it is to maintain the flow of the game by rolling the ball to the server between rallies.
Rally Point	This is the system of scoring a point whenever a rally is won.

Interval	The time between sets. The changes of courts within the sets are not to be regarded as intervals.
Interfering	Any action which will create an advantage against the opponent team or any action which prevent an opponent from playing the ball.
Outside Object	An object or a person which, while outside the playing court or close to the limit of the free playing space, provides an obstruction to the flight of the ball. For example: overhead lights, the referee's chair, TV equipment, scorer's table, and net posts. Outside objects do not include the antennae since they are considered part of the net.
Sand Levellers (Rakers)	These court assistants use long rakes or long poles with flattened ends to smooth out the sand especially around the court lines and across the central axis of the court between the posts.



BEACH RULES STANDING 2013 - 2016

**To be applied in all
World, International, National and League Competitions
from 1st December 2013**

*Approved by the
World ParaVolley Board of Directors*

PART 2 -

SECTION 3: DIAGRAMS

DIAGRAM 1: THE PLAYING AREA

Relevant Rules: 1, 22.1, 23.1, 24.1, 25.1, 26.1

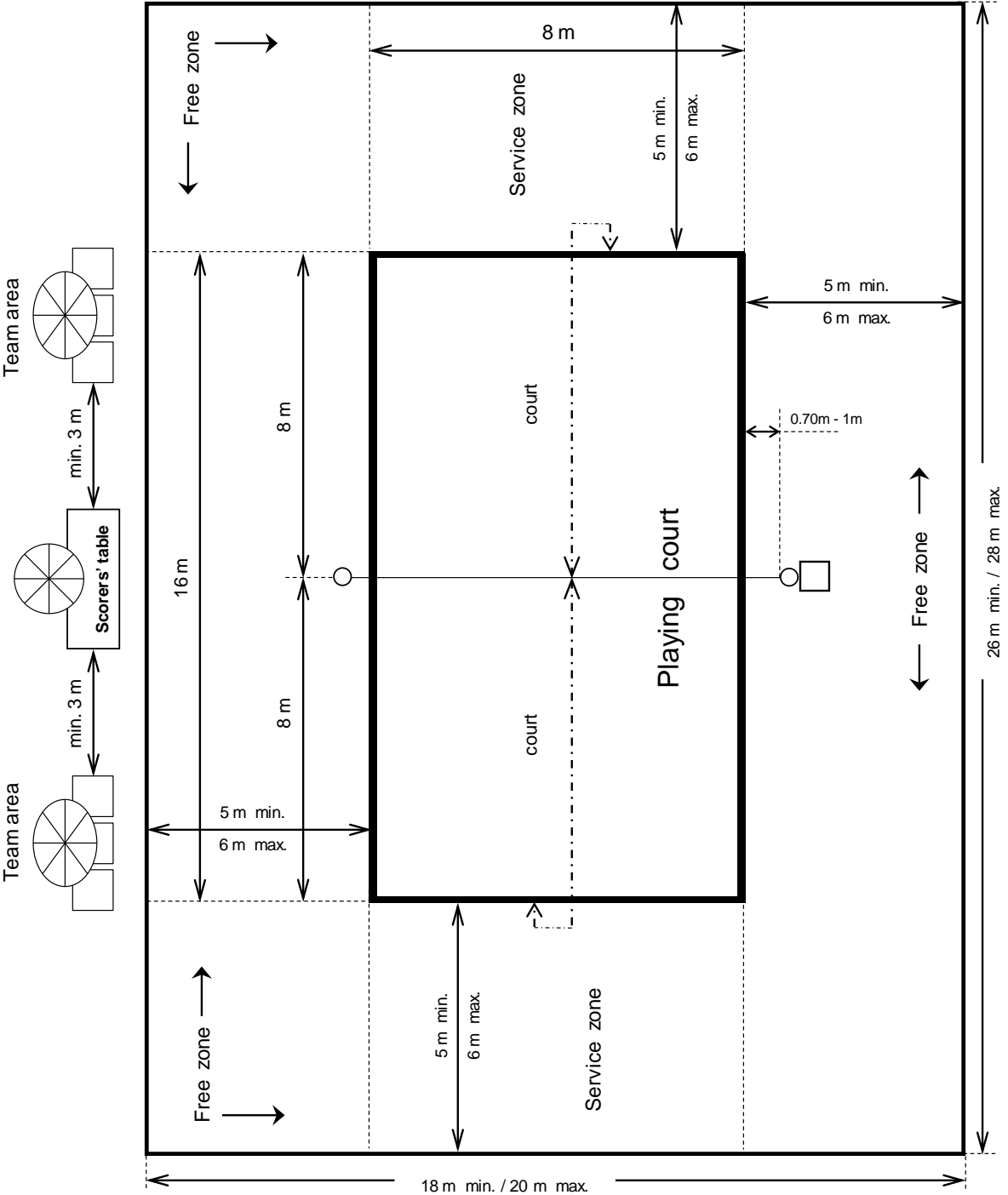

DIAGRAM 2: THE PLAYING COURT

Relevant Rules: 1.1, 1.3, 2.5

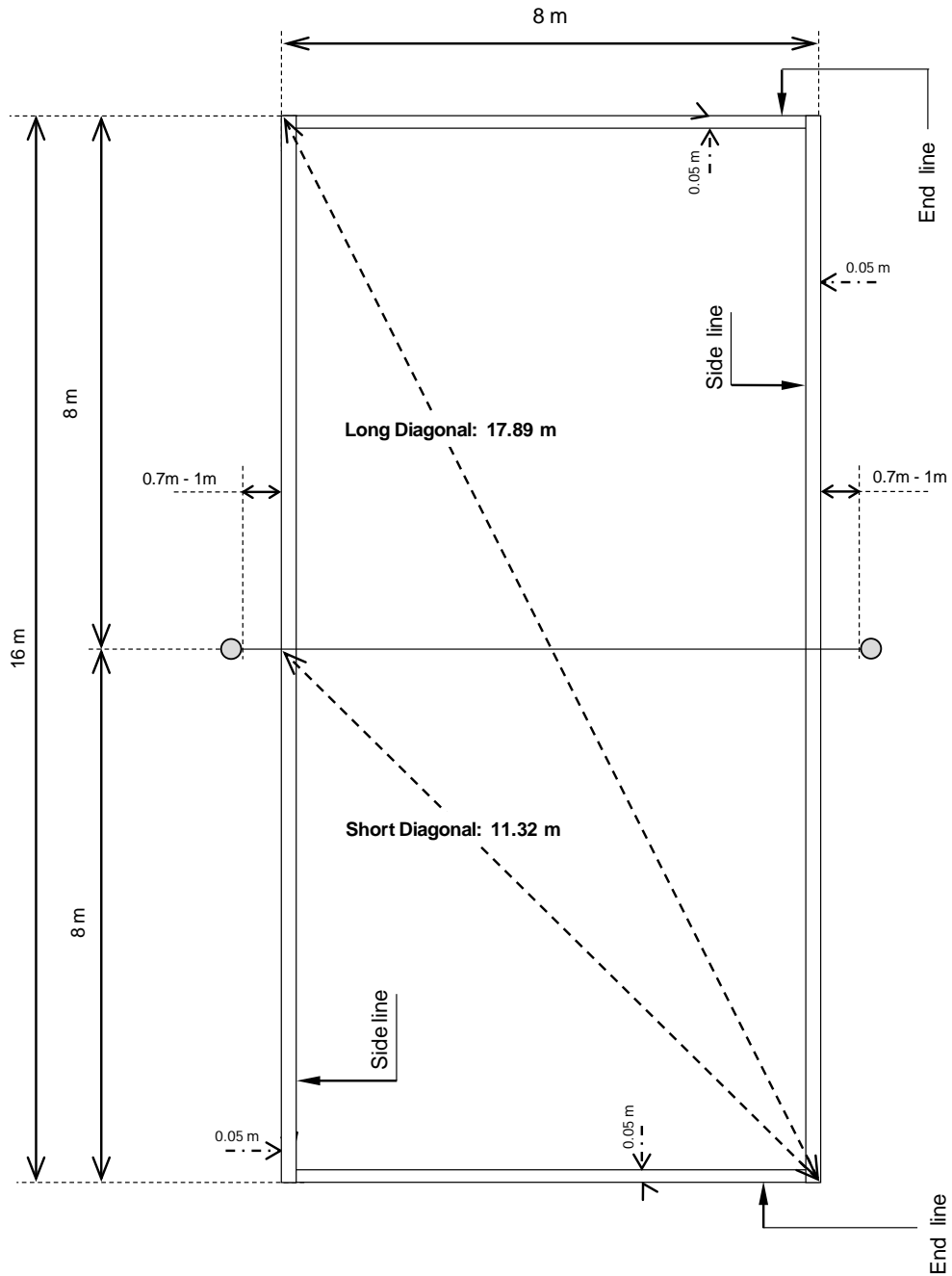
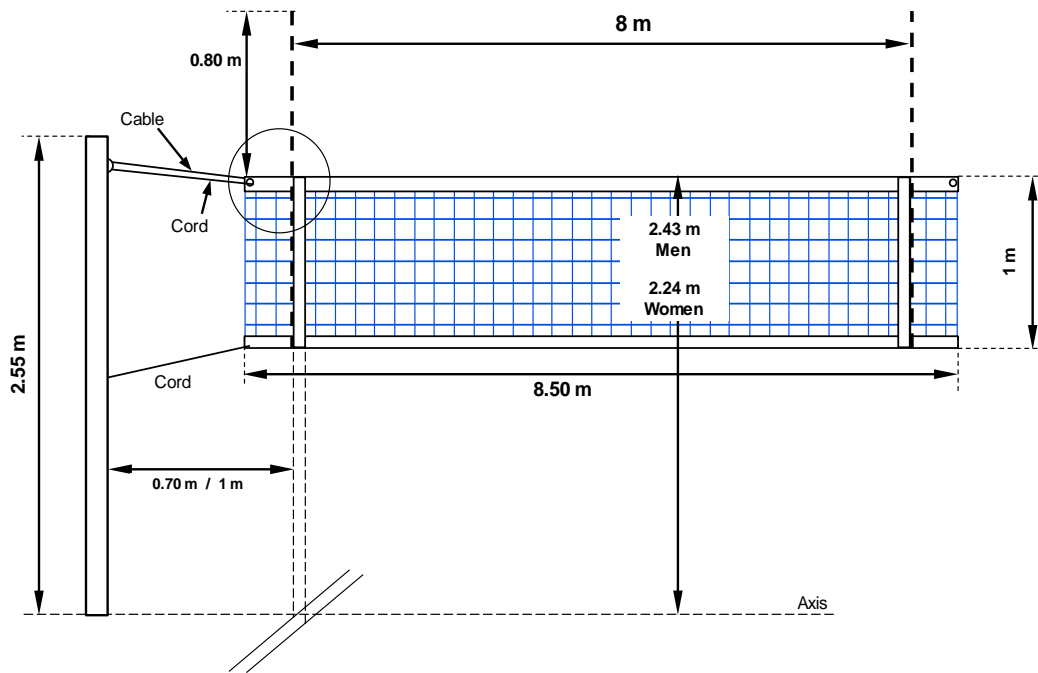

DIAGRAM 3: DESIGN OF THE NET

Relevant Rules: 2, 8.4.3



For WORLD PARAVOLLEY, World and Official Competitions, the net may be adjusted according to Rule 2.1

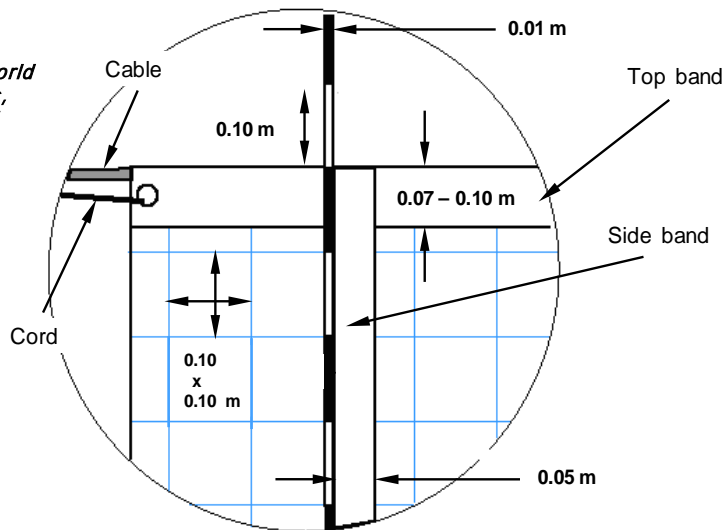
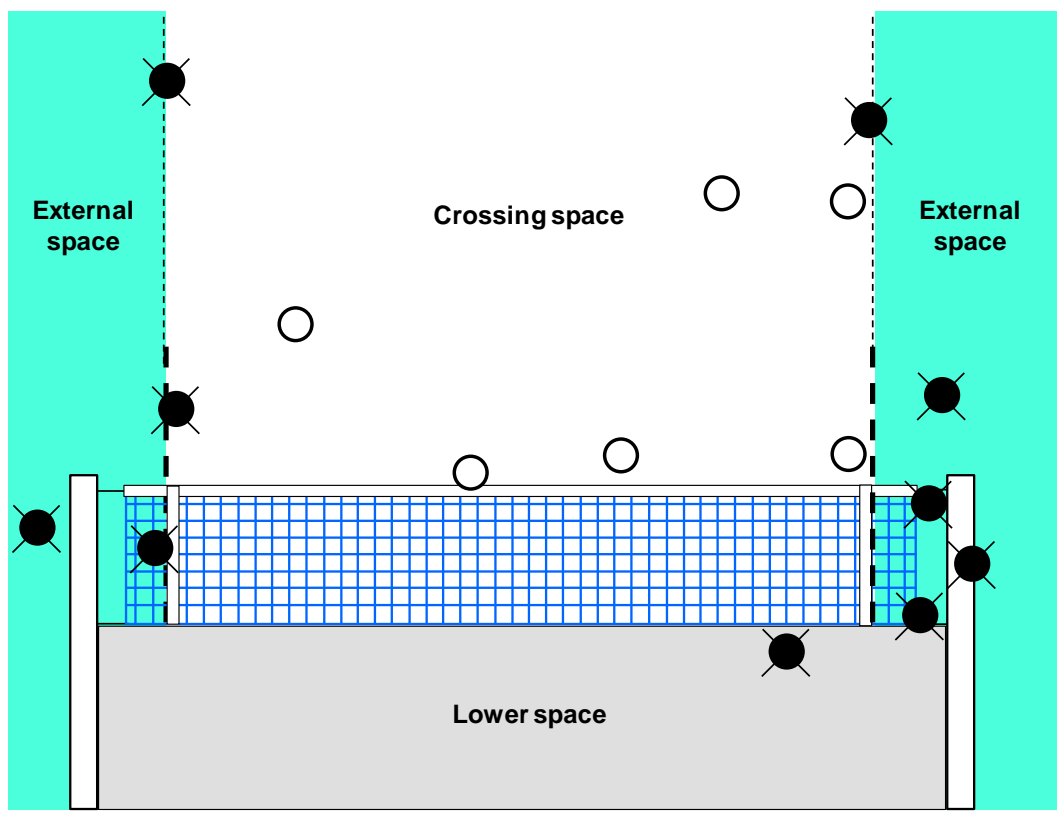

DIAGRAM 4a: BALL CROSSING THE VERTICAL PLANE OF THE NET TO THE OPPONENT COURT

Relevant Rules: 8.4.3, 8.4.4, 8.4.5, 10.1.1, 23.3.2.4, 26.2.1.3, 26.2.1.7



- = Fault
- = Correct crossing

DIAGRAM 4b: BALL CROSSING THE VERTICAL PLANE OF THE NET TO THE OPPONENT FREE ZONE

Relevant Rules: 10.1.2, 10.1.2.1

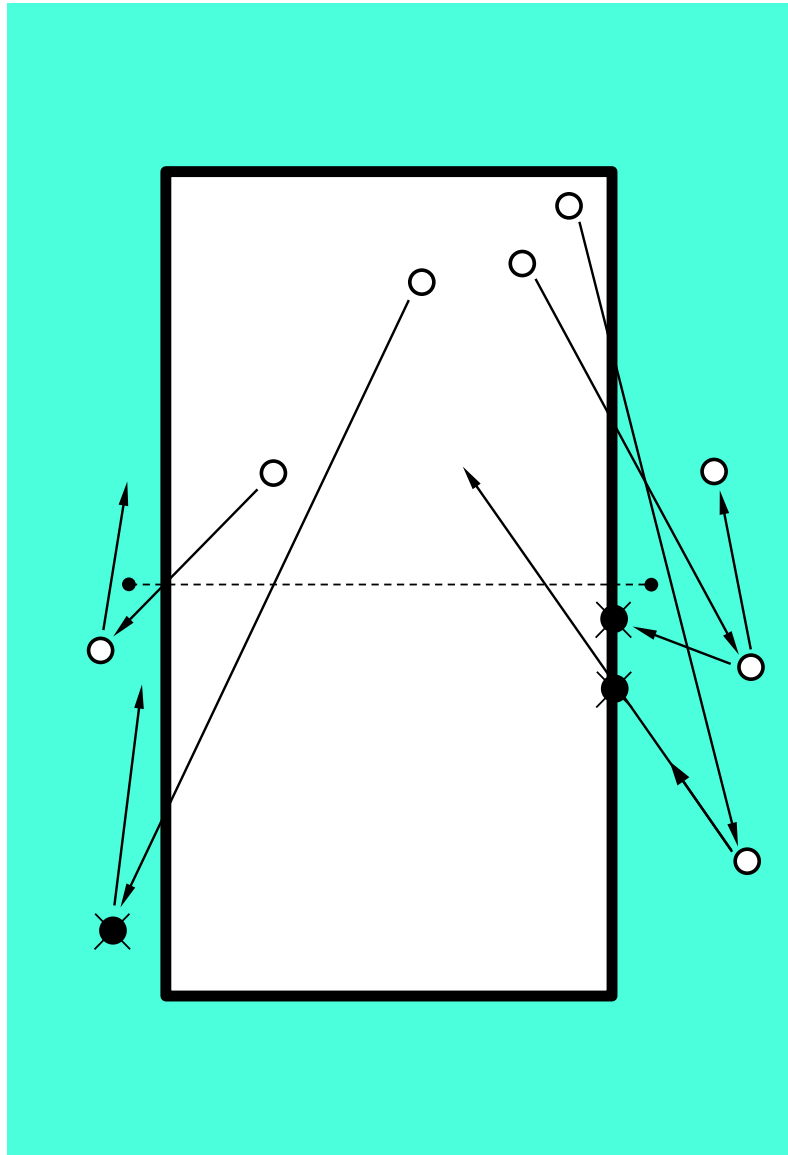

⊗ = Fault

○ = Correct

DIAGRAM 5: SCREEN

Relevant Rules: 12.5.1, 12.5.2, 12.6.2.3, 22.3.2.3

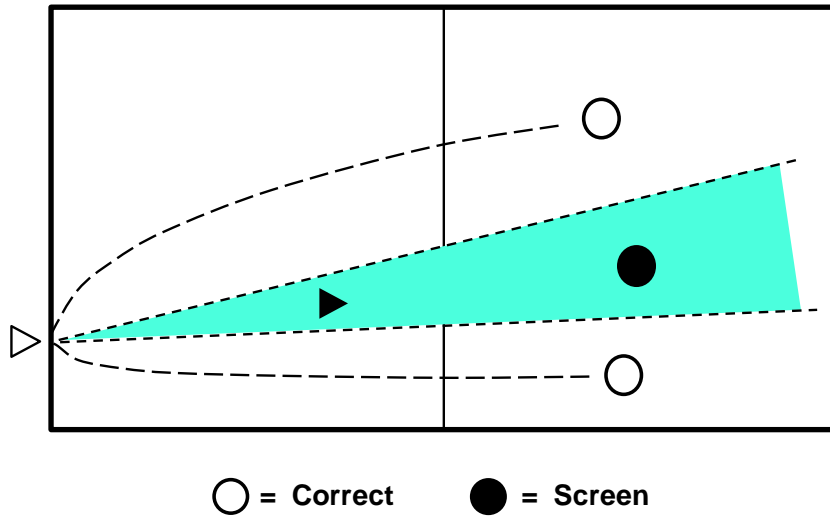

DIAGRAM 6: COMPLETED BLOCK

Relevant Rule: 14.1.3

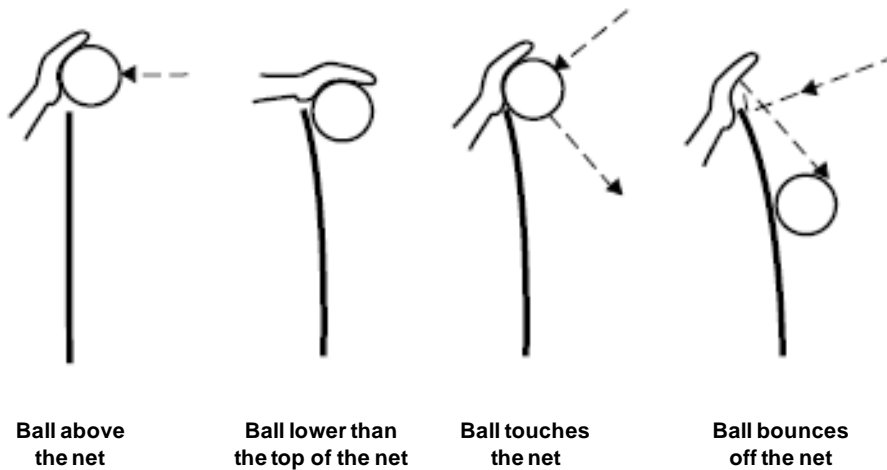

DIAGRAM 7: DETERRENTS AND SANCTIONS

7a: MISCONDUCT SANCTIONS SCALE

Relevant Rules: 20.3, 20.4, 20.5

CATEGORIES	OCCURRENCE	OFFENDER	SANCTION	CARDS	CONSEQUENCE
RUDE CONDUCT (same set)	First	Any member	Penalty	Red	A point and service to the opponent
	Second	Same member	Penalty	Red	A point and service to the opponent
	Third	Same member	Expulsion	Red + Yellow jointly	Team declared incomplete for the set
RUDE CONDUCT (new set)	First	Any member	Penalty	Red	A point and service to the opponent
OFFENSIVE CONDUCT	First	Any member	Expulsion	Red + Yellow jointly	Team declared incomplete for the set
	Second	Same member	Disqualification	Red + Yellow separately	Team declared incomplete for the match
AGGRESSION	First	Any member	Disqualification	Red + Yellow separately	Team declared incomplete for the match

7b: DELAY WARNING SYMBOLS AND SANCTIONS

Relevant Rules: 16.2.2, 16.2.3

CATEGORIES	OCCURRENCE	OFFENDER	DETERRENT or SANCTION	CARDS	CONSEQUENCE
DELAY	First	Any member of the team	Delay Warning	Hand signal No. 25 with Yellow card	Prevention – no penalty
	Second and subsequent	Any member of the team	Delay Penalty	Hand signal No. 25 with Red card	A point and service to the opponent

DIAGRAM 8: LOCATION OF REFEREEING CORPS AND THEIR ASSISTANTS

Relevant Rules: 3.3, 21.1, 22.1, 23.1, 24.1, 25.1, 26.1

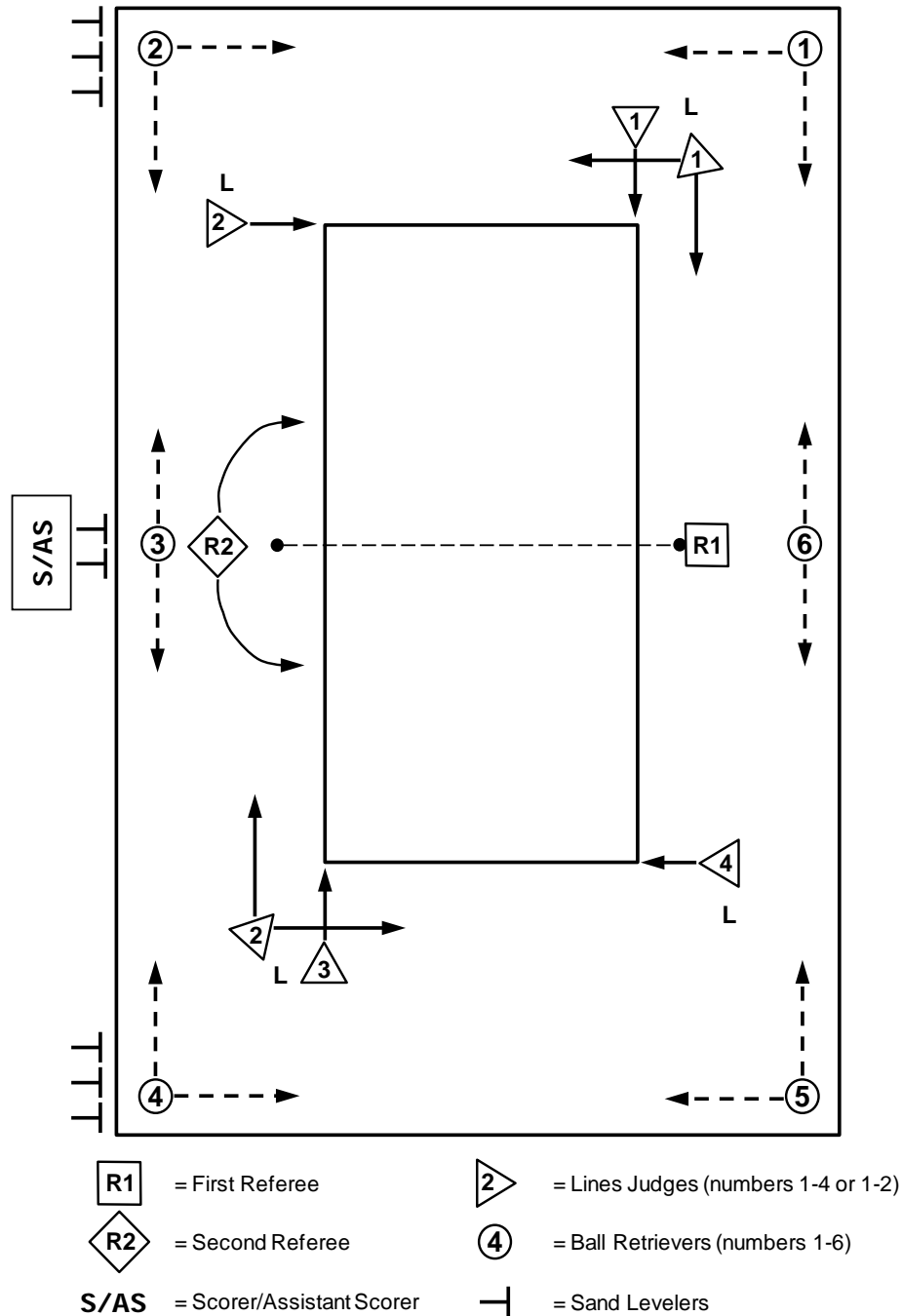

DIAGRAM 9: REFEREES' OFFICIAL HAND SIGNALS

1 AUTHORISATION TO SERVE

Relevant Rules: 12.3, 21.2.1.1

Move the hand to indicate direction of service

F

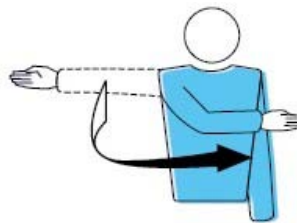

2 TEAM TO SERVE

Relevant Rules: 12.3, 21.2.3.1a, 21.2.3.2c,
21.2.3.3c

Extend the arm to the side of team that will serve

F S



3 CHANGE OF COURTS

Relevant Rules: 18.2, 23.2.5

Raise the forearms front and back and
twist them around the body

F S

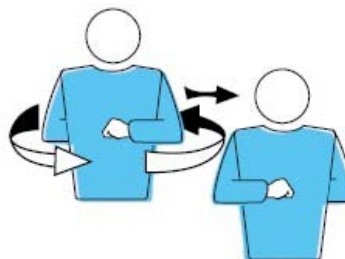

4 TIME-OUT

Relevant Rules: 15, 23.2.5

Place the palm of one hand over the
fingers of the other, held vertically
(forming a T) and then indicate the
requesting team

F S

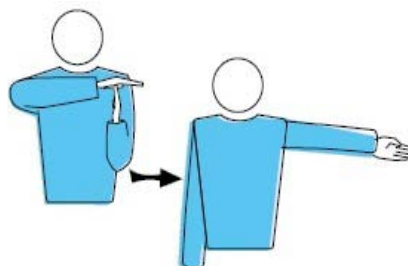

5 MISCONDUCT WARNING

Relevant Rules: 20.1, 20.5

Show a yellow card for warning

F



6 MISCONDUCT PENALTY

Relevant Rules: 20.3.1, 20.5

Show a red card for penalty

F



7 EXPULSION

Relevant Rules: 20.3.2, 20.5

Show both cards jointly for expulsion

F

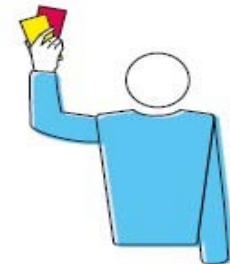

8 DISQUALIFICATION

Relevant Rules: 20.3.3, 20.5

Show red and yellow cards separately for disqualification

F

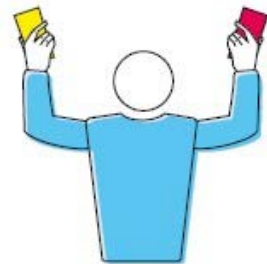

9 END OF SET (OR MATCH)

Relevant Rules: 6.2, 6.3

Cross the forearms in front of the chest, hands open

F S



10 BALL NOT TOSSED OR RELEASED AT THE SERVICE HIT

Relevant Rule: 12.4.1

Lift the extended arm, the palm of the hand facing upwards

F

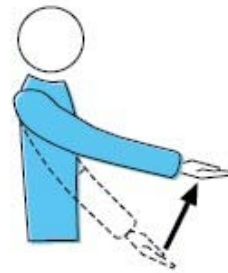

11 DELAY IN SERVICE

Relevant Rule: 12.4.4

Raise five fingers, spread open

F



12 BLOCKING FAULT OR SCREENING

Relevant Rules: 12.5, 14.5, 14.6.3

Raise both arms vertically, palms forward

F



▫ **13 ROTATIONAL FAULT**

Relevant Rules: 7.7.1, 12.6.1.1

Make a circular motion with the forefinger



14 BALL "IN"

Relevant Rules: 6.1.1.1, 8.3

Point the arm and fingers toward the floor



15 BALL "OUT"

Relevant Rules: 8.4.1, 8.4.2, 8.4.3, 8.4.4, 12.6.2.2, 13.2.2

Raise the forearms vertically, hands open, palms towards the body



16 CATCH

Relevant Rules: 6.1.2, 9.3.3, 22.3.2.3b

Slowly lift the forearm, palm of the hand facing upwards



17 DOUBLE CONTACT

Relevant Rules: 6.1.2, 9.1.1, 9.3.4, 22.3.2b

Raise two fingers, spread open



18 FOUR HITS

Relevant Rule: 9.3.1

Raise four fingers, spread open



19 NET TOUCHED BY PLAYER or SERVED BALL FAILS TO PASS TO THE OPPONENT THROUGH CROSSING SPACE

Relevant Rule: 12.6.2.1

Indicate the relevant side of the net with the corresponding hand

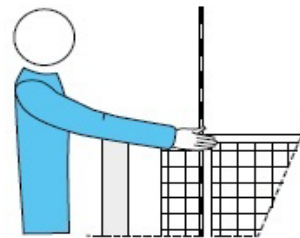

20 REACHING BEYOND THE NET

Relevant Rules: 11.4.1, 13.2.1

Place a hand above the net, palm facing downwards

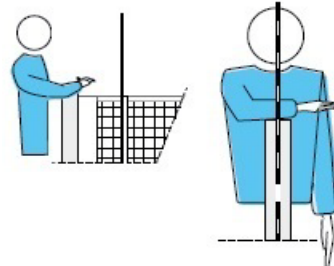

21 ATTACK HIT FAULT

- by a player who completes an attack-hit using an open-handed finger action.
- by a player who completes an attack hit on the opponent's service, when the ball is entirely higher than the top of the net.
- by a player who completes an attack-hit using an overhand pass which has a trajectory not perpendicular to the line of the shoulders, except when he/she is attempting to set to his or her teammate.

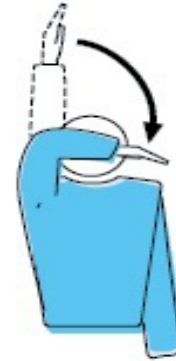

Relevant Rules: 13.2.3, 13.2.4, 13.2.5

Make a downward motion with the forearm, hand open

F

22 INTERFERENCE DUE TO PENETRATION INTO THE OPPONENT'S COURT AND SPACE UNDER THE NET or BALL CROSSES COMPLETELY THE LOWER SPACE UNDER THE NET or THE SERVER TOUCHES THE COURT (THE END LINE INCLUDED) OR THE GROUND OUTSIDE THE SERVICE ZONE or UNLESS FOR THE SERVER, THE PLAYER STEPS OUTSIDE HIS/HER COURT AT THE MOMENT OF THE SERVICE HIT

Relevant Rules: 8.4.5, 11.2.1, 12.4.3, 23.3.2.1, 23.3.2.6

Point to the court under the net or to the respective line

F S



23 DOUBLE FAULT AND REPLAY

Relevant Rules: 6.1.2.2, 12.4.5

Raise both thumbs vertically



24 BALL TOUCHED

Relevant Rule: 14.6.4

Brush with the palm of one hand the fingers of the other, held vertically



25 DELAY WARNING / DELAY PENALTY

Relevant Rules: 15.5.5, 16.2.2, 16.2.3

Cover the wrist with a yellow card (warning) or with a red card (penalty)

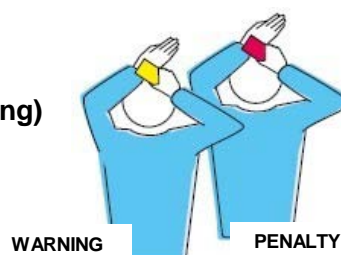

DIAGRAM 10: LINE JUDGES' OFFICIAL FLAG SIGNALS

1 BALL "IN"

Relevant Rules: 8.3, 26.2.1.1

L Point down with flag



2 BALL "OUT"

Relevant Rules: 8.4.1, 26.2.1.1

L Raise flag vertically



3 BALL TOUCHED

Relevant Rule: 26.2.1.2

L Raise flag and touch the top with the palm of the free hand



4 CROSSING SPACE FAULTS, BALL TOUCHED AN OUTSIDE OBJECT, OR FOOT FAULT BY ANY PLAYER DURING SERVICE

Relevant Rules: 8.4.2, 8.4.3, 8.4.4, 12.4.3, 26.2.1.4, 26.2.1.5, 26.2.1.6, 26.2.1.7

L Wave flag over the head and point to the antenna or the respective line



5 JUDGEMENT IMPOSSIBLE

Raise and cross both arms and hands in front of the chest

L

